

ELKAY[®]

SPECIFICATIONS

Lustertone[®] Round Bowl Without Faucet Ledge Models RLR Series Models RLLVR Series – Lavatory with Overflow

GENERAL

Highest quality sink bowl seamlessly formed of #18 gauge, type 304 (18-8) nickel bearing stainless steel. Self-rimming.

DESIGN FEATURES

Bowl Depth: 4-3/4" (RLR9), 6" (RLR12, RLR12FB and RLLVR12), 8" (RLR16, RLR16FB and RLLVR16).

Finish: Exposed surfaces are hand blended to a lustrous high-lighted satin finish.

Underside: Fully undercoated to dampen sound and prevent condensation.

Models RLLVR12 and RLLVR16 single bowl lavatory sinks come with overflow assembly.

OTHER

Drain Opening: 1-1/2" (RLLVR12 and RLLVR16), 2" (RLR9, RLR12 and RLR16), 3-1/2" (RLR12FB and RLR16FB).

OPTIONAL ACCESSORIES

Bottom Grid for Model RLR12FB: LKRBG12.

These sinks comply with ANSI Standard A112.19.3M.

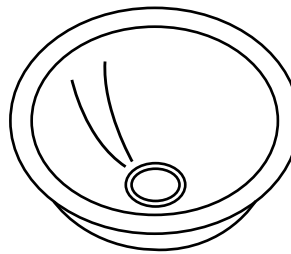

Model RLR9
Model RLR12
Model RLR16

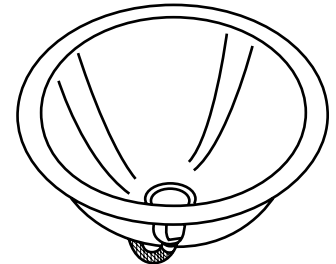

Model RLLVR12
Model RLLVR16

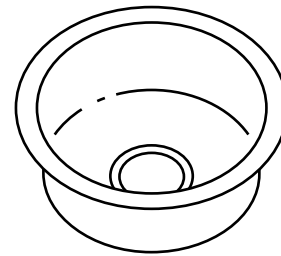

Model RLR12FB
Model RLR16FB

Installation Profile

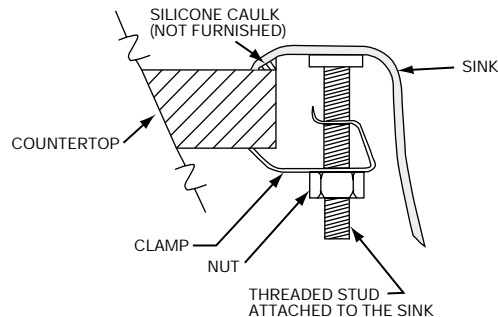

SEE OTHER SIDE FOR PRODUCT DIMENSIONS.

ALL DIMENSIONS IN INCHES, TO CONVERT TO MILLIMETERS MULTIPLY BY 25.4.

In keeping with our policy of continuing product improvement, Elkay reserves the right to change product specifications without notice.

This specification describes an Elkay product with design, quality and functional benefits to the user. When making a comparison of other producers' offerings, be certain these features are not overlooked.

Lustertone® Round Bowl Without Faucet Ledge
 Models RLR Series
 Models RLLVR Series – Lavatory with Overflow

ELKAY®
SPECIFICATIONS

SINK DIMENSIONS (INCHES)

Model Number	Outside Diameter		Depth C	Drain Opening	Cutout in Countertop Use sink upside down as template and cut 5/16" INSIDE sink outline.	Minimum Cabinet Size	Includes Overflow Assembly	Ship. Wt. Lbs.
	A	B						
RLR9	11 ³ / ₈	9	4 ³ / ₄	2		15	No	3
RLR12	14 ³ / ₈	12	6	2		18	No	5 ³ / ₄
RLR12FB	14 ³ / ₈	12	6	3 ¹ / ₂		18	No	5
RLR16	18 ³ / ₈	16	8	2		24	No	13
RLR16FB	18 ³ / ₈	16	8	3 ¹ / ₂		24	No	13
RLLVR12	14 ³ / ₈	12	6	1 ¹ / ₂		18	Yes	7
RLLVR16	18 ³ / ₈	16	8	1 ¹ / ₂		24	Yes	13

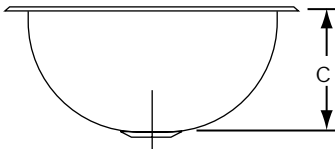
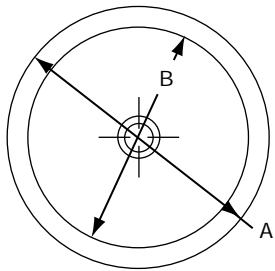

Model RLR9, 12, 16 Illustrated

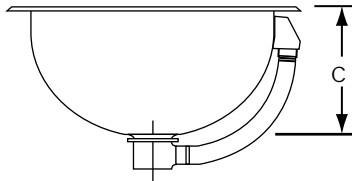
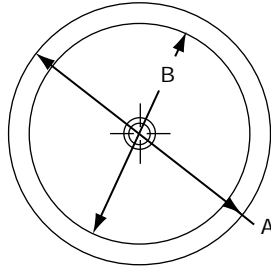

Model RLLVR Series Illustrated

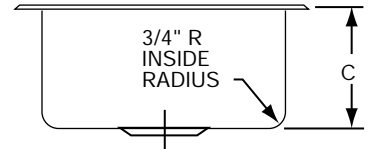
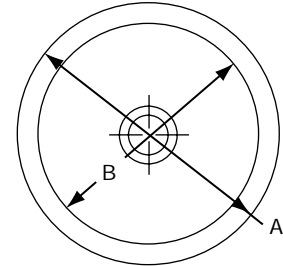

Model RLR12FB, RLR16FB Illustrated